

Self-learning Room Temperature Controller

with two 24-hour operating modes



Mains-independent room temperature controller featuring straightforward operation and an easy-to-read display.

Self-learning two-position controller providing PID control (patented).

Choice of two 24-hour operating modes.

Use

Room temperature control in:

- Single-family and holiday houses
- Apartments and office spaces
- Individual rooms and consulting rooms
- Commercially used spaces

For the control of the following pieces of equipment:

- Solenoid valves of instantaneous water heaters
 - Solenoid valves of atmospheric gas burners
 - Forced draught gas and oil burners
 - Circulating pumps in heating systems
 - Electric direct heating
 - Fans of electric storage heaters
 - Zone valves (normally closed)
-

Functions

- PID control
 - Self-learning or adjustable switching cycle time
 - Two different 24-hour operating modes
 - Remote operation
 - Override button
 - Reset function
 - Detector calibration
 - Frost protection function
 - Minimum limitation of set point
-

Type summary

Room temperature controller with 24-hour time switch

Delivery

The unit is supplied with batteries.

Mechanical design

Plastic casing with an easy-to-read display, easily accessible operating elements and removable cover. The removable battery compartment allows straightforward replacement of the two 1.5 V alkaline batteries. The base plate can be fitted to all commercially available recessed conduit boxes or directly on the wall and can then be wired before fitting the controller to it. The casing accommodates the electronics with the DIP switch. The potential-free changeover contact and the connection terminals are located on the base plate.

Display and operating elements

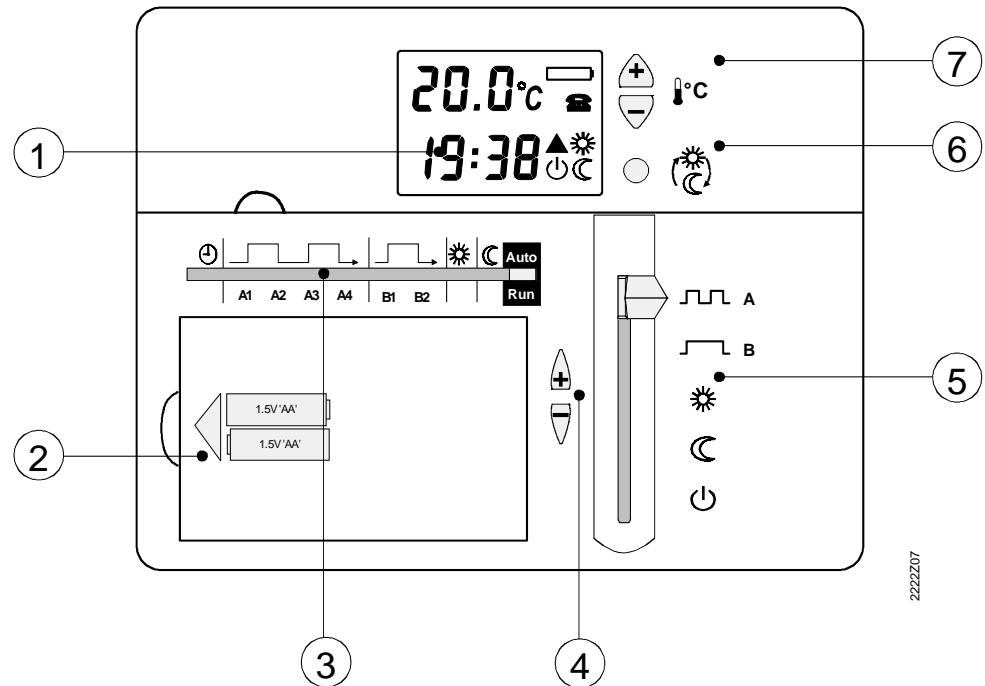

① Display

- Standby with frost protection
- Normal temperature
- Economy temperature
- Heating on
- Remote operation active (REV11T)
- Battery change
- 19:38** Time of day
- 20.0°C** Room temperature (measured)

② Battery compartment

- Two alkaline batteries 1.5 V (AA)

③ Setting slider

- Time
- Switching times A1...A4
- Switching times B1...B2
- Normal temperature

- Economy temperature

Auto Run Operating position

④ Setting buttons

- Set values higher
- Set values lower

⑤ Operating mode selector

- A** 24-hour mode A (with two heating periods)
- B** 24-hour mode B (with one heating period)
- Continuous normal temperature
- Continuous economy temperature
- Standby with frost protection



⑥ Override button



⑦ Warmer/colder buttons

Operating modes

- A** 24-hour mode A with two heating periods
- B** 24-hour mode B with one heating period
- Continuous normal temperature
- Continuous economy temperature
- Standby with frost protection

Set points

	Factory settings	Setting range	Setting range with set point limitation
	20 °C	3...29 °C	16...29 °C
	16 °C	3...29 °C	16...29 °C

The set points  and  are the same in both 24-hour modes (A / B).



Override button





Manual changeover between normal and economy temperature. This manual action will automatically be reset when the next switching action takes place or when the operating mode changes.

Calibration of detector

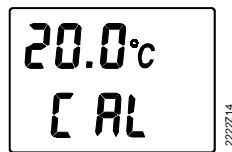

If the displayed room temperature does not agree with the temperature measured, the temperature detector can be recalibrated.

When the setting slider is set to the position , press button . Then, the display will change as follows:



By pressing button  or , the temperature can be changed in increments of 0.2 °C (max. ±2 °C). On completion of the readjustment, the setting slider must be reset to the Auto/Run position.

Reset

When pressing buttons ,  and  simultaneously, all individual settings will be reset to their standard values.

Resetting also serves as a display check:

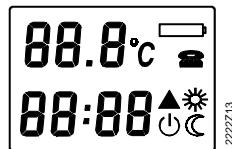

After a reset, all individual settings such as time, day, switching times, etc., must be re-entered.

Technical features

DIP switch

	1	2	3
3...29°C	<input type="checkbox"/>	<input type="checkbox"/>	<input type="checkbox"/>
16...29°C	<input type="checkbox"/>	<input type="checkbox"/>	<input type="checkbox"/>
Self learning	<input type="checkbox"/>	<input type="checkbox"/>	<input type="checkbox"/>
PID 12	<input type="checkbox"/>	<input type="checkbox"/>	<input type="checkbox"/>
PID 6	<input type="checkbox"/>	<input type="checkbox"/>	<input type="checkbox"/>
2-Pt	<input type="checkbox"/>	<input type="checkbox"/>	<input type="checkbox"/>

2222201

Limitation of set point

When using minimum limitation of set point to 16 °C, undesired heat transfer to neighbouring flats is prevented in buildings that have several heating zones. The function can be selected with the DIP switch.

Control

The ACV15... is a two-position controller providing PID control. The room temperature is controlled through the cyclic switching of a regulating unit.

Self-learning mode

The controller is supplied with an active self-learning mode, which enables it to automatically adapt to the controlled system (type of building construction, type of radiators, size of rooms, etc.). After a certain learning period, the controller optimises its parameters and then operates in the mode it has learned.

Exceptional cases

In exceptional cases, where the self-learning mode may not be adequate, it is possible to choose PID 12, PID 6 or 2-Pt mode:

PID 12 mode	Switching cycle of 12 min for normal or slow controlled systems (e.g. massive building structures, large spaces, cast-iron radiators, oil burners).
PID 6 mode	Switching cycle of 6 min for fast controlled systems (e.g. light building structures, small spaces, plate radiators or convectors, gas burners).
2-Pt mode	Pure two-position control with a switching differential of 0.5 °C (± 0.25 °C) for very difficult controlled systems with considerable outside temperature variations.

Technical data

Operating voltage	DC 3 V	Resolution of settings and display	
Batteries (alkaline AA)	2 x 1.5 V	Set points	0.2 °C
Battery life	approx. 3 years	Switching times	10 min
Backup for battery change	1 min max.	Measur. of actual value	0.1 °C
conformity to EEC directive	89/336/EEC	Display of actual value	0.2 °C
low voltage directive	73/23/EEC	Time display	1 min
Switching capacity of relays		Insulation class	
Voltage	AC 24...250 V	to EN 60730-1	II
Current	8 (3.5) A	Degree of protection	
Measuring element NTC 68 k Ω at 25 °C		to EN 60529	IP30
Measuring range	0...40 °C	Electromagnetic compatibility	
Time constant	2 min max.	Immunity	EN 50082-2
Set point setting range		Emissions	EN 50081-1
Normal temperature	3...29 °C	Perm. ambient temperature	
Economy temperature	3...29 °C	Operation	3...35 °C
Set point for frost protection	5 °C	Storage	-25...+60 °C
		Perm. ambient humidity	
		to DIN 40040	G
		Weight	0.2 kg
		Colour	White
			RAL9003

Notes

Engineering

- The room temperature controller should be fitted in the main living room.
- The place of installation should be chosen so that the sensor can capture the room temperature as accurately as possible, without being affected by direct solar radiation or other heating or cooling sources.
- Mounting height is approx. 1.5 m above the floor.
- The unit can be fitted to most commercially available recessed conduit boxes or directly on the wall.

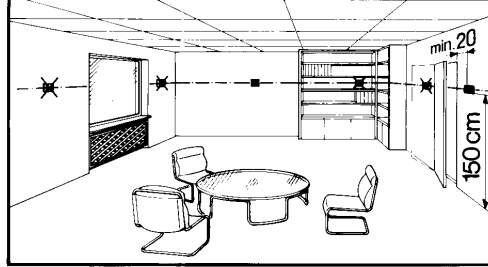

Fitting and installation

- When installing the room temperature controller, the base plate must first be fitted and wired. Then, the unit is engaged at the top, swung downward and secured with a screw.
- For more detailed information, please refer to the installation instructions supplied with the controller.
- For the electrical installation, the local safety regulations and standards must be complied with.
- The remote operation contact T1 / T2 must be wired separately, using a separate shielded cable.

Commissioning

- The battery transit tab, which prevents inadvertent operation of the unit during transport and storage, must be removed from the batteries.
- The control characteristics can be changed with the help of the DIP switches located at the rear of the unit. For detailed information, please refer to the commissioning instructions.
- If the reference room is equipped with thermostatic radiator valves, they must be set to their fully open position.
- If the displayed room temperature does not agree with the measured room temperature, the temperature detector should be recalibrated (please refer to "Calibration of detector").

Connection diagrams

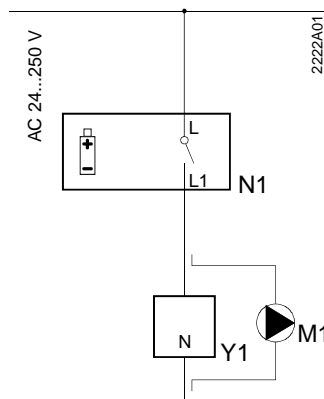

- L Live, AC 24 ... 250 V
- L1 N.O. contact, AC 24 ... 250 V / 8 (3.5) A
- M1 Circulating pump
- N1 ACV 15 controller

Application examples

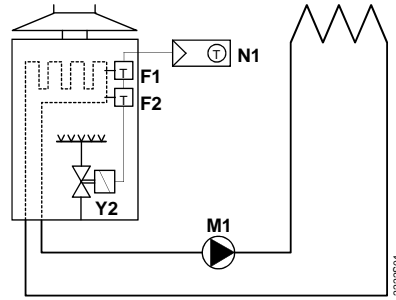

Instantaneous water heater

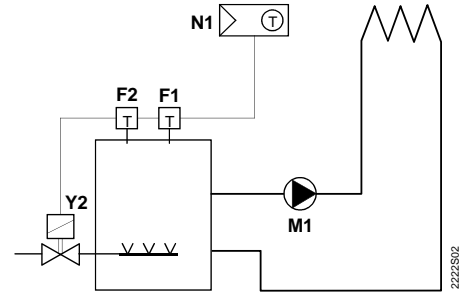

Atmospheric gas burner

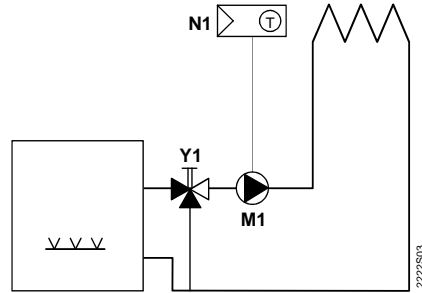

Circulating pump with pre-control by manual mixing valve

F1	Thermal reset limit thermostat	N1	ACV15 room temperature controller
F2	Manual reset safety limit thermostat	Y1	Manually operated three-port valve
M1	Circulating pump	Y2	Solenoid valve

Dimensions

